

SPEC SHEET
F40K
4 to 9 GHz
 Frequency Doublers



Specifications

RF Frequency	4 to 9 GHz
RF VSWR	2.0:1
LO Frequency	8 to 18 GHz
LO Power	10 dBm min 10 dBm typ
LO VSWR	2.0:1

Transfer Characteristics

Conversion Loss	11 dB typ 13 dB max
LO to RF Isolation	20 dB min 25 dB typ

Available Package Styles

Available Package Styles MXT310, SMXT310
 Surface Mount Available

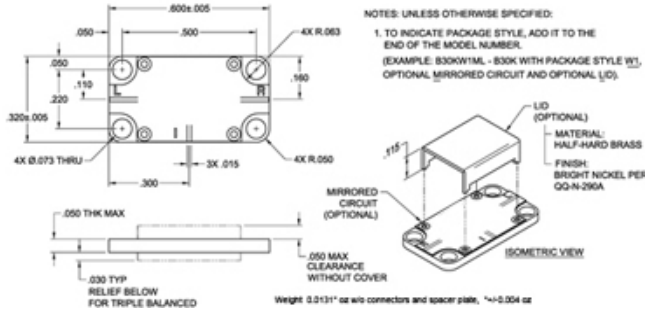

X PACKAGE

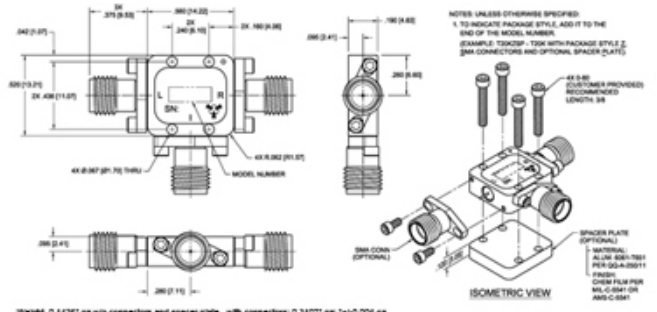
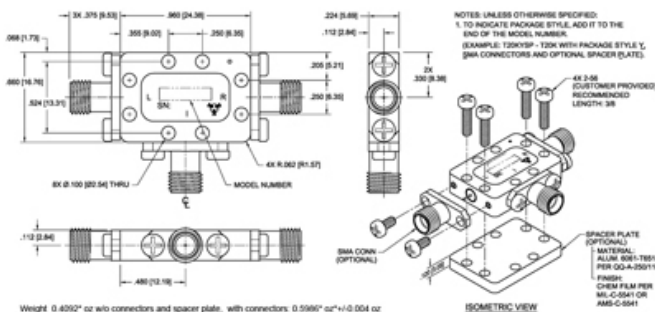
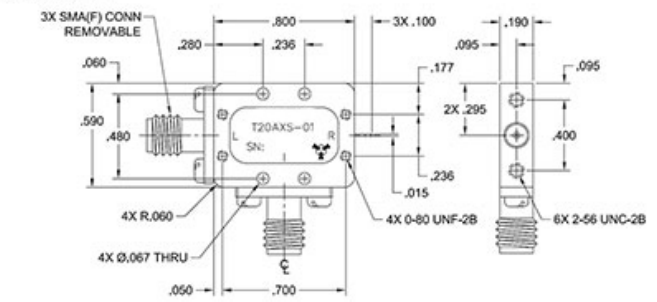

Environmental Ratings

Operating Temp -54 °C to 100 °C

Notes



Microwave RF Components | Manteca, CAL | 1-209-825-3977 | rf.mrcy.com
Specifications subject to change without notice

[Request a Quote](#) | [Ask an Engineer](#)  