

SPEC SHEET
B30A
3 to 7 GHz
 Double Balanced Mixers



Specifications

RF Frequency	3 to 7 GHz
LO Frequency	4 to 8 GHz
LO Power	13 dBm typ

Transfer Characteristics

Conversion Loss	5.5 dB typ 7 dB max
IF Frequency	DC to 2 GHz
LO to RF Isolation	25 dB min 38 dB typ
LO to IF Isolation	20 dB min 35 dB typ
IP3 In	17 dBm typ
P1dB In	7 dBm typ

Available Package Styles

Available Package Styles

W1,X,Y,Z

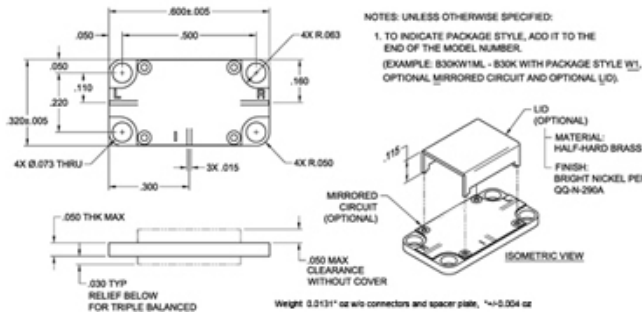

X PACKAGE

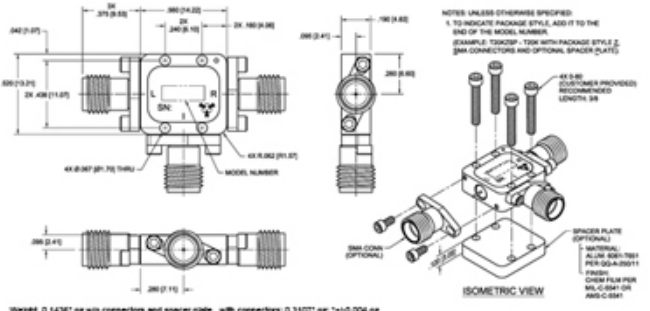
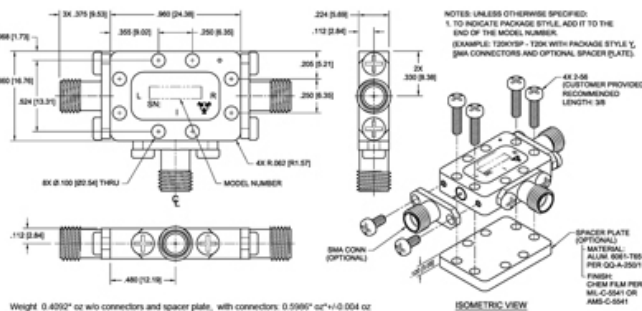
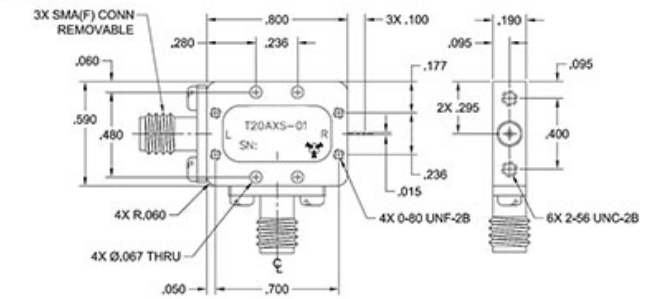

Environmental Ratings

Operating Temp -55 °C to 100 °C

Notes



Microwave RF Components | Manteca, CAL | 1-209-825-3977 | rf.mrcy.com
Specifications subject to change without notice

[Request a Quote](#) | [Ask an Engineer](#)  